

Panasonic

Quick Reference Guide

IP Proprietary Telephone
Model No. **KX-NT551/KX-NT553**
KX-NT556

Thank you for purchasing an IP Proprietary Telephone (IP-PT). Please read this manual carefully before using this product and save this manual for future use. For more details, please refer to the manuals of the PBX.

This product supports the following PBX versions and CODEC types:

- KX-NS1000: PCMPR Software File Version 3.0000 or later
- KX-NCP500/KX-NCP1000: PBMPR Software File Version 8.0000 or later
- KX-TDE100/KX-TDE200: PMMPR Software File Version 8.0000 or later
- KX-TDE600: PGMPR Software File Version 8.0000 or later
- CODEC: G.722, G.711, G.729A

Note

- In this manual, the suffix of each model number is omitted unless necessary.
- The illustrations may differ from the appearance of the actual product.

Trademarks

- Plantronics is a trademark or registered trademark of Plantronics, Inc.
- All other trademarks identified herein are the property of their respective owners.

Important Information

FCC and Other Information

This equipment has been tested and found to comply with the limits for a Class B digital device, pursuant to Part 15 of the FCC Rules. These limits are designed to provide reasonable protection against harmful interference in a residential installation. This equipment generates, uses, and can radiate radio frequency energy and, if not installed and used in accordance with the instructions, may cause harmful interference to radio communications. However, there is no guarantee that interference will not occur in a particular installation. If this equipment does cause harmful interference to radio or television reception, which can be determined by turning the equipment off and on, the user is encouraged to try to correct the interference by one or more of the following measures:

- Reorient or relocate the receiving antenna.
- Increase the separation between the equipment and receiver.
- Connect the equipment into an outlet on a circuit different from that to which the receiver is connected.
- Consult the dealer or an experienced radio/TV technician for help.

CAUTION

Any changes or modifications not expressly approved by the party responsible for compliance could void the user's authority to operate this device.

FCC Declaration of Conformity

Trade Name: Panasonic

Model Number: KX-NT551/KX-NT553/KX-NT556

Responsible Party:

Panasonic Corporation of North America

Two Riverfront Plaza

Newark, NJ 07102-5490 U.S.A.

Telephone No.: 1-800-211-PANA (7262)

WHEN PROGRAMMING EMERGENCY NUMBERS AND (OR) MAKING TEST CALLS TO EMERGENCY NUMBERS:

- a. Remain on the line and briefly explain to the dispatcher the reason for the call.
- b. Perform such activities in the off-peak hours, such as early morning or late evenings.

This equipment is hearing aid compatible.

When you hold the phone to your ear, noise might be heard in your Hearing Aid. Some Hearing Aids are not adequately shielded from external RF (radio frequency) energy. If noise occurs, use the speakerphone option (if applicable) when using this phone. Consult with your audiologist or Hearing Aid manufacturer about the availability of Hearing Aids which provide adequate shielding to RF energy commonly emitted by digital devices.

For users in Canada only

- This Class B digital apparatus complies with Canadian ICES-003.
- This product meets the applicable Industry Canada technical specifications.



Compliance with TIA-1083 standard:



Telephone handsets identified with this logo have reduced noise and interference when used with T-Coil equipped hearing aids and cochlear implants.

Accessory Information

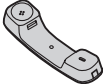
Included Accessories

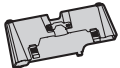
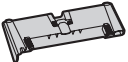
Handset (1)	Handset Cord (1)	Stand (1)	
		KX-NT551 	KX-NT553/ KX-NT556 

Note





For extra orders for the accessories, call toll-free: 1-800-332-5368. (For users in the United States only)

Optional Accessories

	KX-NT551	KX-NT553	KX-NT556
AC adaptor* ¹	<ul style="list-style-type: none"> ● For users in the United States: KX-A239 (PQLV206) ● For users in Canada: KX-A239X (PQLV206) 		
Wall mount kit	KX-A432	KX-A433	
Add-on 48 key module	—	KX-NT505* ²	

*1 To order an optional AC adaptor, please order using the "KX-A239" or "KX-A239X" model number (not "PQLV206"). Can also be used with the KX-NT505.

*2 KX-NT505 has the following accessories.

Stand (1)	Wall mounting adaptor (1)	Screws for wall mounting (3)* ¹	Screws for attaching to the unit (2)
			

*1 Two screws for attaching the KX-NT505 to a wall.
One screw for attaching the wall mounting adaptor to the unit.

Location of Controls

KX-NT551

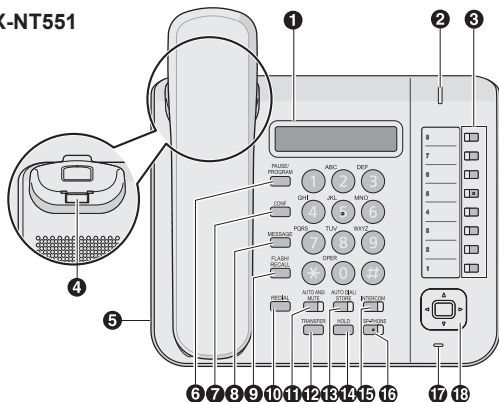

KX-NT553
KX-NT556

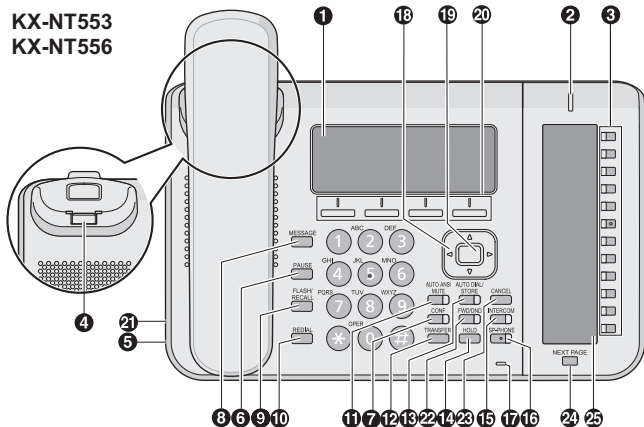

- ❶ **Main LCD (Liquid Crystal Display):**
KX-NT551: 1 line, KX-NT553: 3 lines, KX-NT556: 6 lines
- ❷ **Message/Ringer Lamp:**
When you receive an intercom call, the lamp flashes green, and on an outside call, the lamp flashes red. When someone has left you a message, the lamp stays on red.
- ❸ **Flexible CO Buttons:** Used to seize an outside line or perform a feature that has been assigned to the key.
- ❹ **Handset Hook:** Keeps the handset stable when the unit is mounted on a wall.
- ❺ **Headset Jack**
- ❻ **PAUSE/PROGRAM (KX-NT551 only):** Used to insert a pause when storing a telephone number. This button is also used for programming this unit.
PAUSE (KX-NT553/KX-NT556 only): Used to insert a pause when storing a telephone number.
- ❼ **CONF:** Used to establish a multiple party conversation.
- ❽ **MESSAGE:** Used to leave a message waiting indication or call back the party who left the message waiting indication.
- ❾ **FLASH/RECALL:** Used to disconnect the current call and make another call without hanging up.
- ❿ **REDIAL:** Used to redial the last dialed number.
- ⓫ **AUTO ANS/MUTE:** Used to receive an incoming call in hands-free mode or mute the microphone/handset during a conversation.
- ⓬ **TRANSFER:** Used to transfer a call to another party.
- ⓭ **AUTO DIAL/STORE:** Used for System/Personal Speed Dialing or storing programme changes.
- ⓮ **HOLD:** Used to place a call on hold.
- ⓯ **INTERCOM:** Used to make or receive intercom calls.
- ⓰ **SP-PHONE (Speakerphone):** Used for performing hands-free operations.

Location of Controls

- ⑰ **Microphone:** Used for hands free conversations.
- ⑱ **Navigator Key:** Used to adjust the volume and the display contrast or select desired items.
- ⑲ **ENTER*1:** Used to assign the selected item.
- ⑳ **Soft Buttons (S1-S4)*1:** S1-S4 (located from left to right) are used to select the item displayed on the bottom line of the display.
- ㉑ **EHS (Electronics Hook Switch) Jack*1**
- ㉒ **FWD/DND*1:** Used to switch Call Forwarding or Do Not Disturb on your extension.
- ㉓ **CANCEL*1:** Used to cancel the selected item.
- ㉔ **NEXT PAGE*1:** Used to switch the page for the Self Labeling feature.
- ㉕ **Sub LCD*1:** 12 lines

*1 KX-NT553/KX-NT556 only

Before Operating the Telephone

Speaker volume

While in a hands-free conversation
Press [▲] or [▼] to adjust the volume.

Handset/Headset volume*1

While using the handset or headset
Press [▲] or [▼] to adjust the volume.

Ringer volume

While on-hook or receiving a call
Press [▲] or [▼] to adjust the volume.

LCD Contrast (For main LCD)*2

While on-hook

1. Press the **PROG** soft button (S1).*3
2. Enter 0①.
3. Press [ENTER].*4
4. Press [▲] or [▼] to adjust the LCD contrast.
5. Press [ENTER].*4
6. Press [CANCEL].*3

*1 If you hear your own voice through the handset or headset, decrease the volume.

*2 To change the sub LCD contrast of the KX-NT553/KX-NT556, enter 0⑤ in Step 2.

*3 For KX-NT551, press [PAUSE/PROGRAM].

*4 For KX-NT551, press [AUTO DIAL/STORE].

Before Operating the Telephone

Ring Tone

1. Press the **PROG** soft button (S1).^{*1}
2. Press a flexible CO button or [INTERCOM] 2 times.
3. Enter 2 digits (01-30) using the dial keys (0-9), or press [▲] or [▼] to select the ring tone.
4. Press [ENTER].^{*2}
5. Press [CANCEL].^{*1}

LCD Backlight

While on-hook

1. Press the **PROG** soft button (S1).^{*1}
2. Enter ①④.
3. Press [ENTER].^{*2}
4. Press a dial key to select the LCD backlight mode.
①: Automatic
①: Always ON
②: Always OFF
5. Press [ENTER].^{*2}
6. Press [CANCEL].^{*1}

^{*1} For KX-NT551, press [PAUSE/PROGRAM].

^{*2} For KX-NT551, press [AUTO DIAL/STORE].

Feature Operations

Making Calls

Calling

[To an extension]

1. Go off-hook.
2. Dial an extension number.

[To an outside party]

1. Go off-hook.
2. Press a flexible CO button.
3. Dial the outside party's phone number.

Redial

1. Go off-hook.
2. Press [REDIAL].

Quick Dialing

1. Go off-hook.
2. Dial a quick dialing number.

Doorphone Call

1. Go off-hook.
2. Enter ***31**.
3. Enter a doorphone number (2 digits).
4. After the confirmation tone, talk.

System Speed Dialing

1. Go off-hook.
2. Enter ****.*1**
3. Enter a system speed dialing number (3 digits).

*1 You can also press [AUTO DIAL/STORE].

Feature Operations

Personal Speed Dialing

[To store]

1. Go off-hook.
2. Enter ***30**.
3. Enter a personal speed dialing number (2 digits).
4. Enter the phone number to store (max. 32 digits).^{*1}
5. Press **#**.
6. After the confirmation tone, go on-hook.

[To dial]

1. Go off-hook.
2. Enter ******.^{*2}
3. Enter *****.
4. Enter a personal speed dialing number (2 digits).

One-touch Dialing

[To store]

1. Press the **PROG** soft button (S1).^{*3}
2. Press a flexible CO button.
3. Enter **2**.
4. Enter the number to store (max. 32 digits).^{*1}
5. Press **[ENTER]**.^{*4}
6. Enter the text to store (max. 12 digits).^{*5}
7. Press **[ENTER]**.^{*5}
8. Press **[CANCEL]**.^{*3}

[To dial]

1. Go off-hook.
2. Press the flexible CO button assigned as a One-touch Dialing button.

^{*1} Enter the outside line access number before an outside phone number.

^{*2} You can also press **[AUTO DIAL/STORE]**.

^{*3} For KX-NT551, press **[PAUSE/PROGRAM]**.

^{*4} For KX-NT551, press **[AUTO DIAL/STORE]**.

^{*5} KX-NT553/KX-NT556 only

During a Conversation

Call Hold

[To hold]

1. Press [HOLD].
2. After the confirmation tone, go on-hook.

[To retrieve a call at the holding extension]

1. Go off-hook.
2. Press a flexible CO button or [INTERCOM].

[To retrieve an outside call from another extension]

1. Go off-hook.
2. Press a flexible CO button.

Call Transfer

[To an extension]

1. Press [TRANSFER].
2. After the confirmation tone, dial an extension number.
3. Talk.
4. Go on-hook.

[To an outside party]

1. Press [TRANSFER].
2. After the confirmation tone, press a flexible CO button.
3. Dial an outside phone number.
4. Talk.
5. Go on-hook.

Setting the Telephone According to Your Needs

Do Not Disturb

1. Go off-hook.
2. Enter *71.
3. Press a dial key to select the setting.
0: Both outside and intercom calls
1: Outside calls only
2: Intercom calls only
4. To enable Do Not Disturb, enter 1.
To cancel Do Not Disturb, enter 0.
5. After the confirmation tone, go on-hook.

Timed Reminder

[To set]

1. Go off-hook.
2. Enter *7601.
3. Enter the hour and minute (4 digits).
4. If 12-hour-time display is set, enter 0 (AM) or 1 (PM).
5. Enter 0 (1 time) or 1 (daily).
6. After the confirmation tone, go on-hook.

[To cancel]

1. Go off-hook.
2. Enter *7600.
3. After the confirmation tone, go on-hook.

[To stop or answer the ring back]

1. Press [INTERCOM], or go off-hook.

Useful Features

Multiple Party Conversation

[To add other parties during a conversation]

1. Press [CONF].
2. After the confirmation tone, dial the phone number of the party to add.
3. Talk to the new party.
4. Press [CONF].
5. After the confirmation tone, talk with multiple parties.

[To leave a conference]

1. Press [CONF].
2. After the confirmation tone, go on-hook.

Before Leaving Your Desk

Call Forwarding

1. Go off-hook.
2. Enter *7①.
3. Press a dial key to select the types of calls to apply this feature to.
 - ①: Both outside and intercom calls
 - ②: Outside calls only
 - ③: Intercom calls only
4. Press a dial key to select the status.
 - ④: All calls
 - ⑤: Busy
 - ⑥: No answer
 - ⑦: Busy/No answer
 - ⑧: Cancel*1
5. Enter an extension number, and then enter #, or enter a CO line access number, an outside phone number, and then enter #.
6. After the confirmation tone, go on-hook.

*1 If you enter ⑧ in Step 4, you can skip Step 5.

Self Labeling (KX-NT553/KX-NT556 only)

The KX-NT553/KX-NT556 features 12 flexible buttons, with an LCD screen next to the buttons. Each item can be named on the LCD screen through personal or system programming to reflect the function of its corresponding flexible button. Additionally, the KX-NT553 (KX-NT556) flexible buttons can be organized into 2 (3) "pages", allowing you to assign a total of 24 (36) items to the 12 flexible buttons. You can toggle between pages by pressing [NEXT PAGE], as follows:

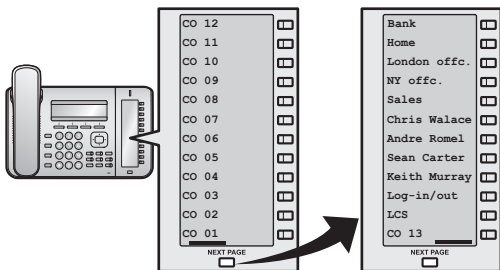

Storing a One-touch Dialing button, and setting the displayed text for the Self Labeling LCD

1. Press the **PROG** soft button (S1).
2. Press a flexible CO button, or press [NEXT PAGE], and then press a flexible CO button.
3. Enter ②.
4. Enter the number to store (max. 32 digits).^{*1}
5. Press [ENTER].
6. Enter the text to store (max. 12 digits).
7. Press [ENTER].
8. Press [CANCEL].

^{*1} Enter the outside line access number before an outside phone number.

Installation and Setup

Note

- Panasonic assumes no responsibility for injuries or property damage resulting from failures arising out of improper installation or operation inconsistent with this documentation.

Attaching a KX-NT505 to the KX-NT553/KX-NT556

The KX-NT505 allows 48 additional flexible CO buttons to be added to this unit. These buttons are used to seize an outside line, make a call using One-touch Dialing, or perform a feature that has been assigned to the key.



1. Open the flat cable cover of your unit.

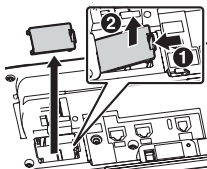

2. Attach the KX-NT505 to your unit with the 2 screws*1.

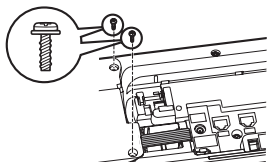

3. Plug the flat cable into the connector (1), then bend the cable slightly as shown (2).

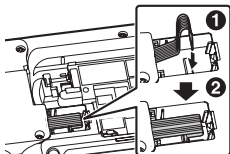

4. Close the cover.

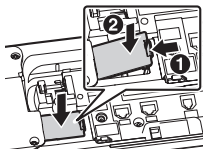

*1 Included with the KX-NT505.

Installation and Setup

CAUTION

- Before you install or uninstall the Add-on 48 key module, turn off the unit by disconnecting the AC adaptor (if connected) and the Ethernet cable connected to the switching hub.

Note

- Up to 4 Add-on 48 key modules can be connected. If 2 or more key modules are connected, an AC adaptor must be connected to the second key module. If only 1 key module is connected, an AC adaptor is not required.
- Use only the Panasonic AC adaptor. See “Optional Accessories”, Page 5.

Attaching the Stand

KX-NT551

- 1 Insert the catches of the stand into the hooks located in the unit.
- 2 Gently push the stand in the direction indicated until it locks into place. The stand will be mounted.

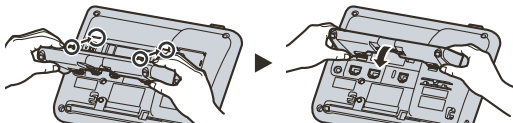

KX-NT553/KX-NT556/KX-NT505

- 1 Insert the catches (A) of the stand into hooks located in the unit.
- 2 Gently push the stand in the direction indicated until it locks into place. The stand will be mounted in the high position.

Example: KX-NT556

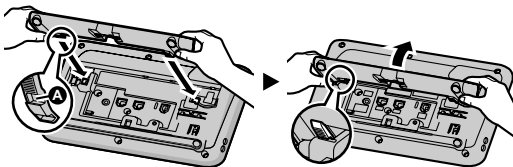

Removing the Stand

KX-NT551

- 1 Remove the stand in the direction indicated while pushing the catches of the stand with both hands as shown.

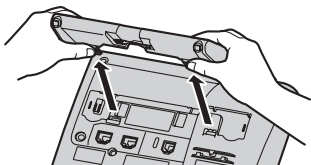

KX-NT553/KX-NT556/KX-NT505

- 1 Hold the stand with both hands.
- 2 Gently rotate the stand in the direction indicated until it is released.

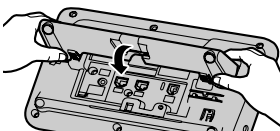

Example: KX-NT556

Connections

KX-NT551

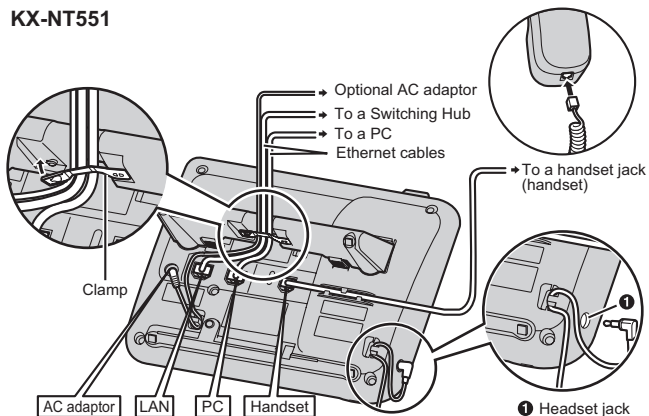

KX-NT553/KX-NT556

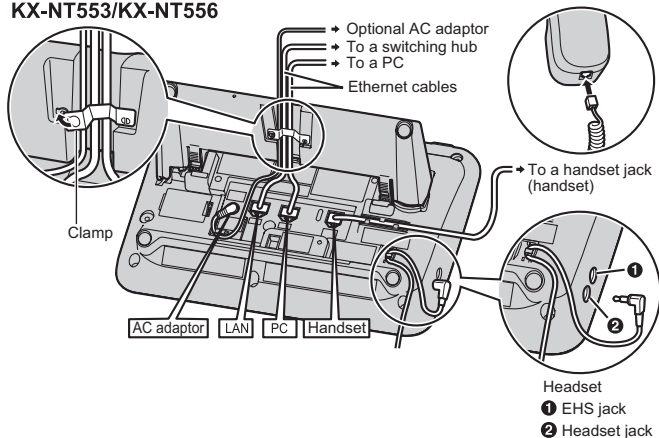

Note

- When connecting a headset, the following headsets can be used with this unit. (Not all operations with the headsets can be guaranteed.)

- Wired headsets
Panasonic KX-TCA400 or KX-TCA430
- EHS headsets (KX-NT553/KX-NT556 only)
Selected Plantronics®-brand headsets

For up-to-date information about headsets that have been tested with this unit, refer to the following web sites:

<http://panasonic.net/pcc/support/pbx/>

When selecting Ethernet cables (not included)

- Use flexible cables without jack covers. Do not use cables with a hard coating that may tear or crack when bent.
To prevent damage to the cables, use cables that do not protrude from the bottom of the base.
Connect the cables as shown in the following illustration.

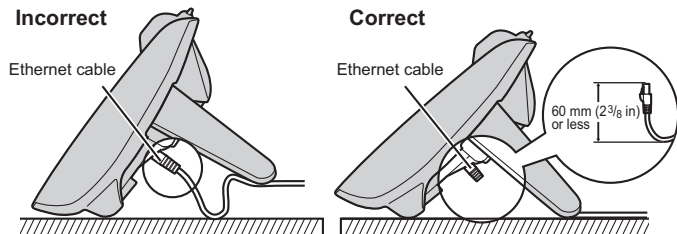

- Use a straight CAT 5e (or higher) Ethernet cable (not included) that is 6.5 mm (1/4 in) in diameter or less.

When connecting to a switching hub

- If PoE is available, an AC adaptor is not needed.
- KX-NT551/KX-NT553/KX-NT556 comply with the PoE Class 3 standard.

When connecting a PC

- The PC port does not support PoE for connected devices.

When connecting cables and the AC adaptor

- Ensure that the Ethernet cables and the AC adaptor cord are clamped to prevent damage to the connectors.

Wall Mounting

Note

- When mounting the KX-NT553/KX-NT556 with a KX-NT505 on the wall, attach the KX-NT505 to the KX-NT553/KX-NT556 first, and then mount them on the wall. For detail about the attaching, see “Attaching a KX-NT505 to the KX-NT553/KX-NT556”, Page 17.
- When mounting the KX-NT553/KX-NT556 with a KX-NT505 on a wall, only ONE KX-NT505 can be attached.

- 1 Insert the tabs of the wall mounting adaptor into the designated openings in the base, and then slide the wall mounting adaptor in the direction of the arrow until it clicks.

KX-NT551

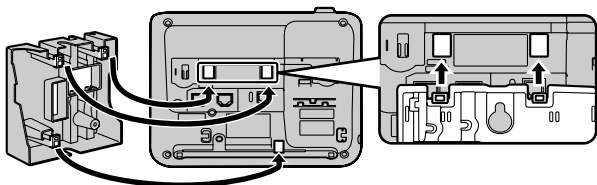

KX-NT553/KX-NT556 with KX-NT505

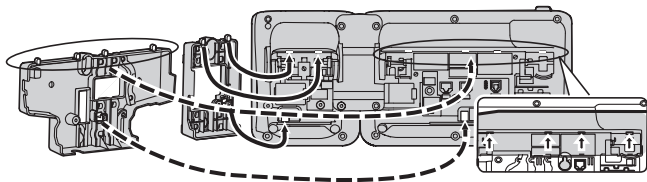

- Fasten the wall mounting adaptor(s) to the base with the screw(s).
(Recommended torque: 0.4 N·m [4.08 kgf·cm/3.54 lbf·in] to 0.6 N·m [6.12 kgf·cm/5.31 lbf·in])
- Connect the cables to the unit as shown in the illustration below.
- Drive the screws into the wall either 83 mm (3 1/4 in) or 100 mm (3 15/16 in) apart, and mount the unit on the wall.

Example: KX-NT553/KX-NT556 with KX-NT505

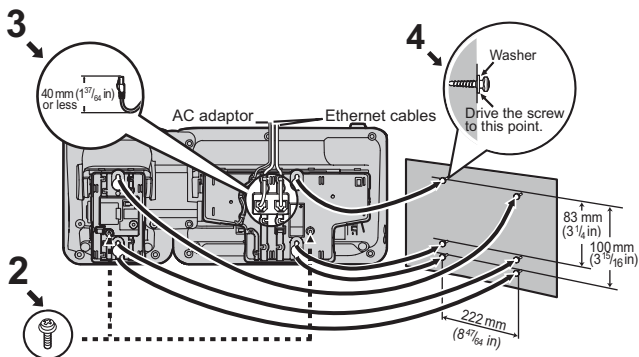

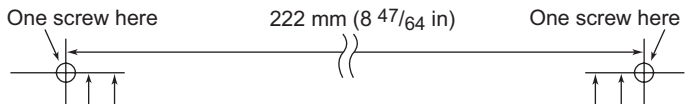

WALL MOUNTING TEMPLATE

1. Drive the screws into the wall as indicated.
2. Hook the unit onto the screw heads.

Note:

- If the KX-NT505 is mounted beside a KX-NT553/KX-NT556, leave 222 mm (8 $\frac{47}{64}$ in) of space between the 2 screws for the IP-PT and the 2 screws for the KX-NT505, as indicated above.

This space is abbreviated in this template and must be measured.

for KX-NT551/KX-NT553/KX-NT556

100 mm (3 $\frac{15}{16}$ in)
83 mm (3 $\frac{1}{4}$ in)

for KX-NT505

83 mm (3 $\frac{1}{4}$ in)
100 mm (3 $\frac{15}{16}$ in)

